

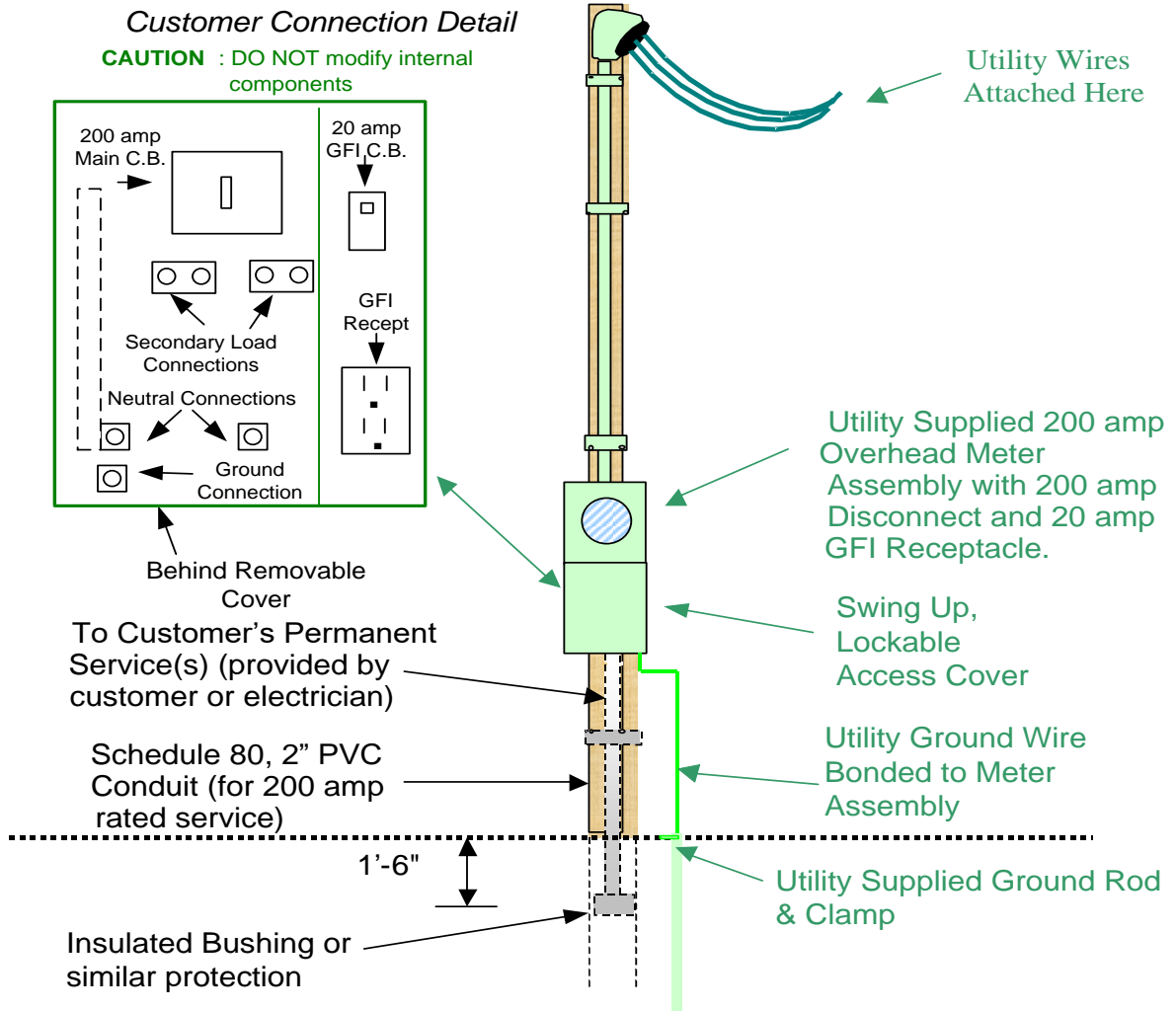

**UTILITY SUPPLIED POLE MOUNTED
OVERHEAD METER ASSEMBLY,
RESIDENTIAL, 200 AMP RATED**
--To Be Used for ALL New Electric Services--



Notes:

Crow Wing Power retains ownership of Utility supplied meter assembly. **DO NOT modify any internal components.** There is a \$550 Meter Entrance Charge for this assembly. All Customer connections and/or services attached to the CWP meter assembly must be approved by the Minnesota State Board of Electricity. Consult with the State Wiring Inspector **BEFORE** hooking up to a Manufactured or Mobile Home. Web-site: [http:// www.dli.mn.gov](http://www.dli.mn.gov)

TYPICAL APPLICATIONS

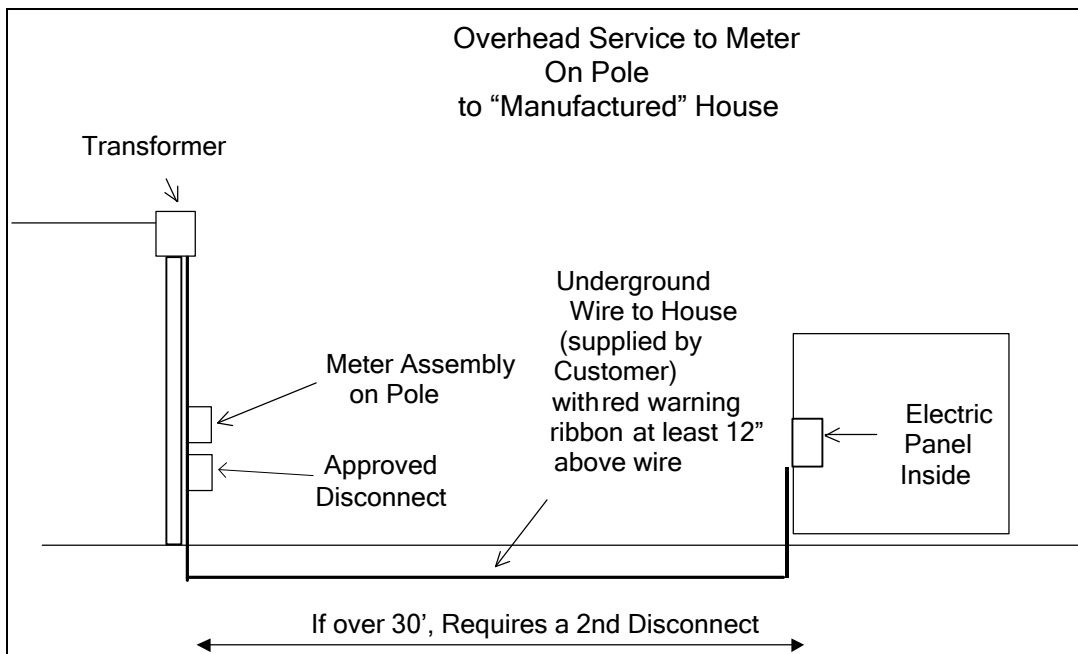
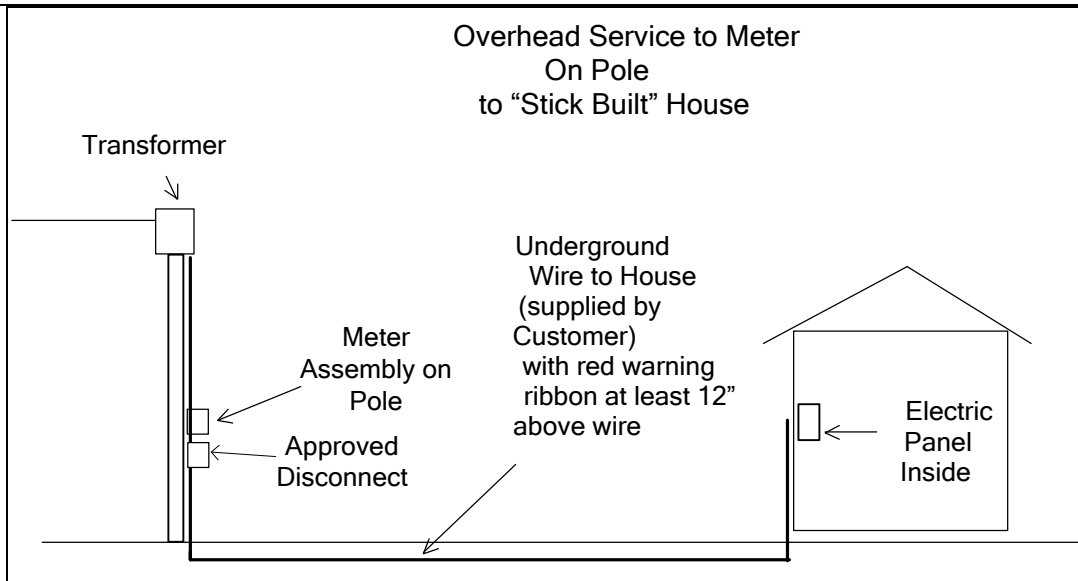

- **PLEASE NOTE:** To be used for ALL new Overhead Electric Services.
- Customer supplied wiring from the load side of the meter equipment must be sized in accordance with the National Electric Code.
- Wire size of a residential single phase dwelling service can be sized using the table notes for Article 310:15 (B)(6). This includes a separate, dedicated ground wire.
- Any secondary residential type services for heating or air conditioning (continuous duty service) are not subject to derating and must be sized from table 310:16. This is for both direct and subtractive metering.
- Red warning ribbon is placed at least 12" above underground wiring.